

**VAIA Two-hole bath mixer for free-standing assembly with hand shower set -
Brushed Champagne (22kt Gold)**

VAIA

25 943 819



- spout: circular, air-enriched flow
- max. flow 24.6 l/min at 3 bar flow pressure
- Hand shower: COMPACT RAIN, max. flow rate 6.8 l/min (at 3 bar)
- hand shower with anti-scale system
- 221mm projection
- pivotable spout 360°
- rotary diverter for bath/shower
- total height 920 mm
- stand pipes height 628 mm
- height up to aerator 816 mm
- slide-on rosettes Ø 100 mm
- gauge 150 mm
- metal shower hose 1250mm with integrated anti-twist protection
- pivotable shower holder on the right foot

Intrinsic protection against back flow.

Note: Local building codes may require the use of an anti-scald device. Please refer to remote pressure balance valve (35 910 970 90)

Intrinsic protection against back flow.

Note: Local building codes may require the use of an anti-scald device. Please refer to remote pressure balance valve (35 910 970 90)

	Brushed Champagne (22kt Gold)	25 943 819-46
	Chrome	25 943 819-00
	Brushed Platinum	25 943 819-06
	Platinum	25 943 819-08
	Dark Chrome	25 943 819-19
	Brushed Durabronze (23kt Gold)	25 943 819-28
	Brushed Bronze	25 943 819-42
	Champagne (22kt Gold)	25 943 819-47
	Brushed Dark Platinum	25 943 819-99

Required miscellaneous



- Concealed floor mounting -**
- max. recess depth 160 mm
 - min. recess depth 80 mm

35 951 970-90
0010

**VAIA Two-hole bath mixer for free-standing assembly with hand shower set -
Brushed Champagne (22kt Gold)**

VAIA

25 943 819
mm [inches]

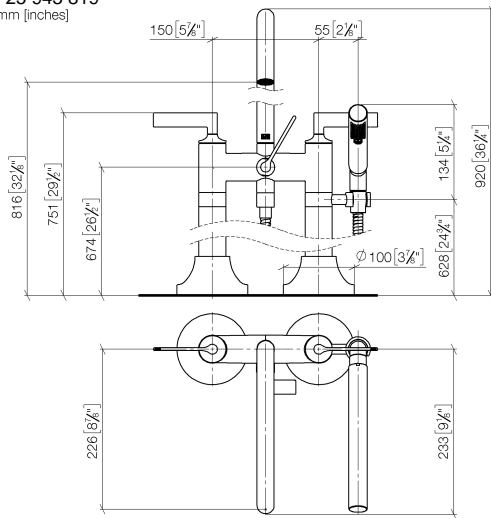

Flow rate chart



Codes & Standards

ASME	California Energy
A112.18.1/CSA	Commission
B125.1	(CEC)



VAIA Two-hole bath mixer for free-standing assembly with hand shower set -
Brushed Champagne (22kt Gold)

VAIA

25 943 819

Certificates

Belgauqa_22_276_2 LGA_29294.
7_2.

VAIA Two-hole bath mixer for free-standing assembly with hand shower set -
Brushed Champagne (22kt Gold)

VAIA

25 943 819

